

TEXENSE[®] MONITORING FASTENER

**Your turnkey solution
for bolted joints
applications**

a brand of
texys
GROUP



Introduction

Texense® Monitoring Fastener, your turnkey solution



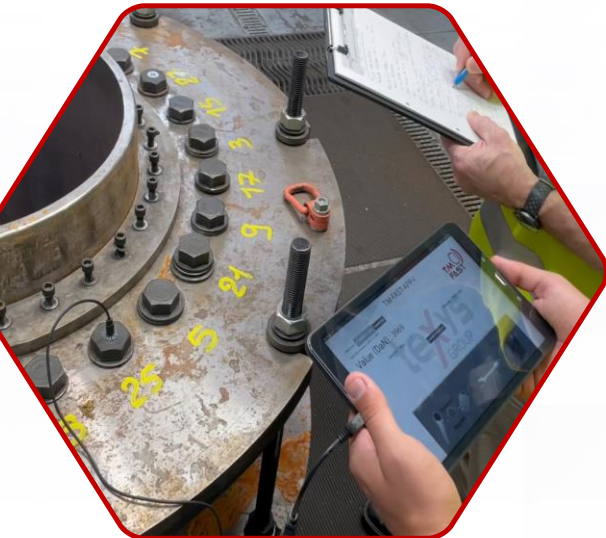

TEXYS Group offers you TM-FAST®, our complete monitoring solution, from initial fastening to preventive maintenance through instrumented bolts for connected assemblies.

The main advantage of the TM-FAST® is that it does not modify the mechanical characteristics of the bolt while allowing convenient and direct access to the measurement. This solution has been qualified on parts with diameters from M4 to M33, with the aim of instrumenting any type of screw.



Depending on your needs, whether on a test bench or on-site, TEXYS Group will provide the most suitable TM-FAST® application, whether off the shelf or custom, among our 3 current versions:

-  Wired (TH)
-  Embedded intelligence (EI)
-  Wireless (W)

Texense® Monitoring Fastener, your turnkey solution



All the products and solutions developed and offered by TM-FAST® by Texys, whether STANDARD or CUSTOM, allow the realization of instrumented installations in perfect adequacy with our clients' expectations.

With TM-FAST®, you benefit from a complete solution:

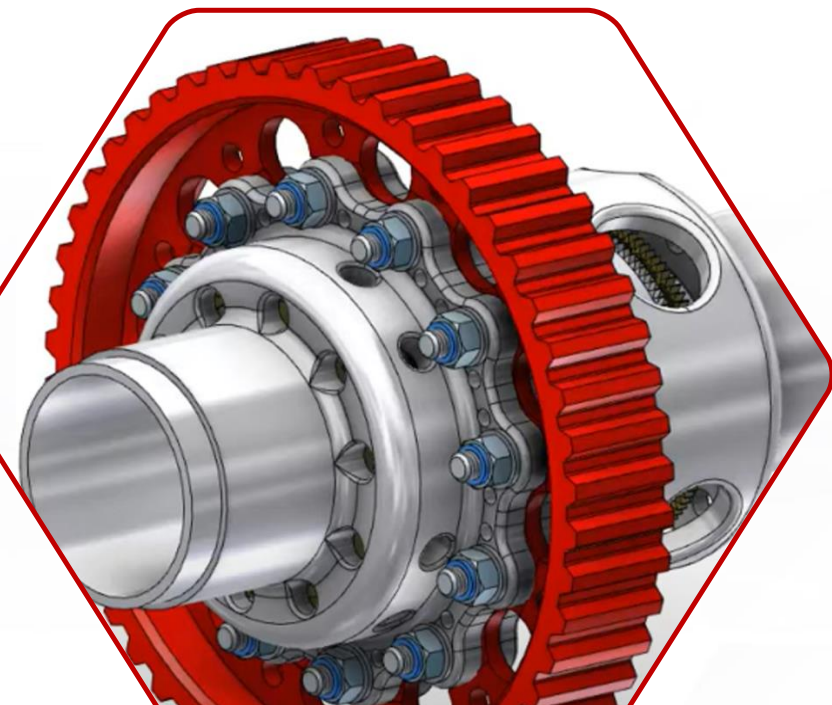

Fastening

A measurement of the clamping load during the initial fastening and an adjustment based on your specifications



Monitoring

A follow-up of the fastening of each instrumented bolt, at a frequency defined according to your needs and possible readjustment with the values obtained



Preventive maintenance

Monitoring of the evolution of the tension in the assembly over time



**The TM-FAST[®]
solution**



The TM-FAST® technology is based on custom strain gauges fixed inside the screw head.

Our technology has been patented* in Europe, the USA, Japan and China.

Strain sensors use the sensitivity of gauges to measure the intensity of tensile effects on the bolt.

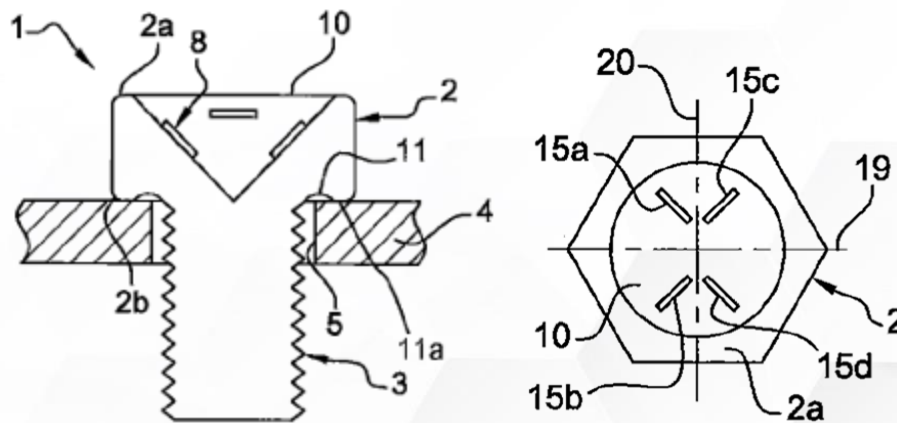

The gauge is fixed inside the screw head, with no degradation of the mechanical strength of the bolt.



*Principle of the TM-FAST® technology

TEXYS Group patent

TM-FAST® in a nutshell:

-  Qualified on diameters from M4 to M33
-  Bolts with hexagonal shape
-  Our objective: instrument any type of screw

The TM-FAST® range



We currently offer **3 technological variants** of TM-FAST® to meet the exact needs of our customers.

 **TH** range: strain sensor with **remote** measurement conditioner

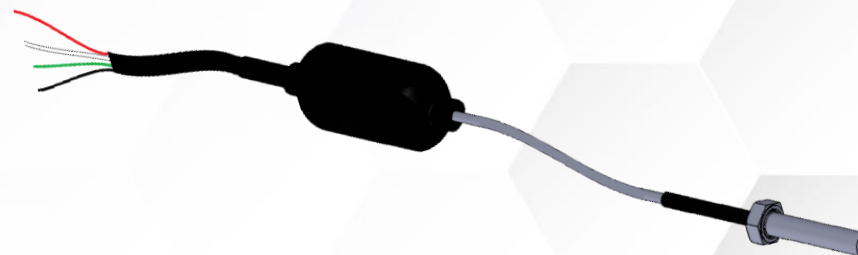

 **EI** range: strain sensor with **integrated** measurement conditioner

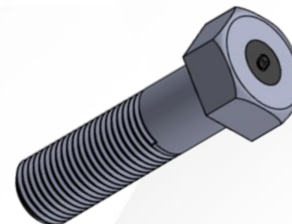

 **W** range: strain sensor with **integrated** measurement conditioner & **wireless** technology



Other options are under study, always responding to the needs expressed by our customers.

TM-FAST-TH range



In its **TH** range, TM-FAST® offers a **wired, instrumented bolt** integrating the sensitive element (strain sensor) in the screw head and a **remote measurement conditioner** (memory and measurement) outputting a **modulating analog signal**.

⬡ The **CO** version incorporates a binder connector between the screw head and the conditioner.

⬡ The **EM** version remains wired which does not create a separation between the conditioner and the screw head.

⬡ The **MC** version incorporates a magnetic connector on the screw head, separating it from the conditioner.



TM-FAST-TH-MC



TM-FAST-TH-EM

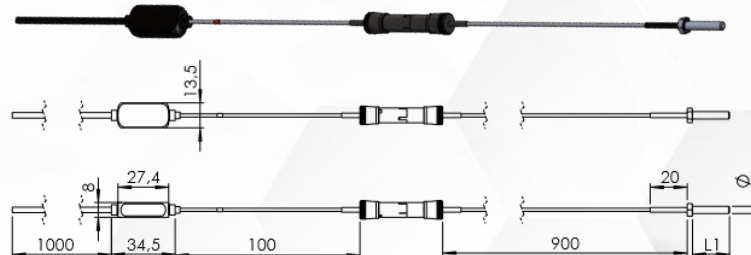

CAD & mechanical drawings for the TM-FAST-TH-CO

Technical specs

- 5% FS hysteresis error
- Repeatability error 0.2%
- FS Non-linearity error 0.5% FS
- Temperature range -20/+100°C
- TH max cut-off frequency: 15 kHz
- IP66 protection
- Smart dimensions: 34.5*13.5*5.8 mm without adaptable cable lengths (default: 1000mm *2)
- Applicable effort (adjustable)
- 0-5V analog output

TM-FAST-EI range



In its **EI** range, TM-FAST® offers a **wired, instrumented bolt** integrating the sensitive element (strain sensor) in the screw head and an **integrated measurement conditioner** (memory and measurement) outputting an **analog signal**.

⬡ The **MC** version incorporates a magnetic connector on the screw head. The TM-FAST-EI-MC works with the TM-FAST-EIAST dongle which offers an additional layer allowing filtering and conversion of the analog value into daN. This dongle offers a serial link via USB.



TM-FAST-EI-MC

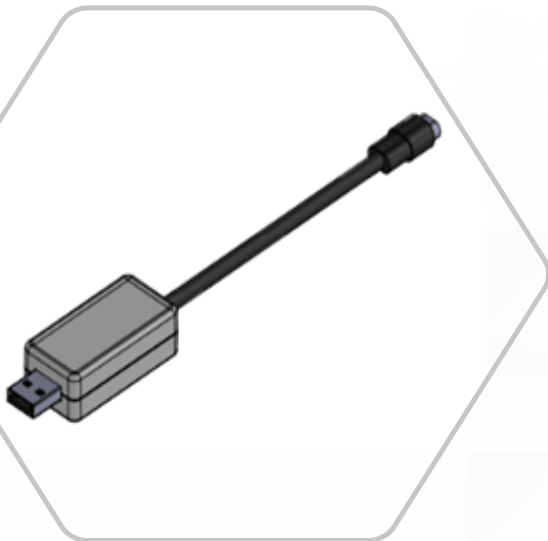

TM-FAST-EIAST

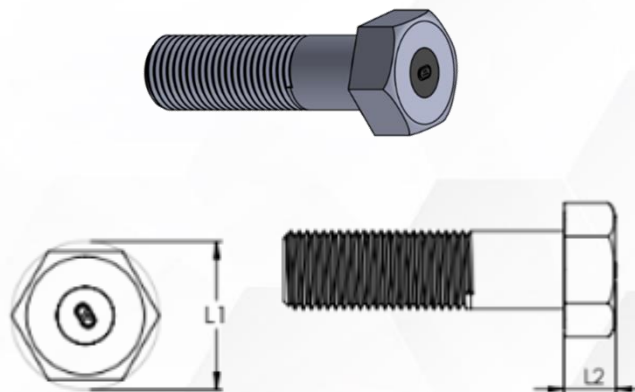

CAD & mechanical drawings for the TM-FAST-EI

Technical specs

- 5% FS hysteresis error
- Repeatability error 0.2%
- FS Non-linearity error 0.5% FS
- Temperature range -20/+100°C
- EI max cut-off frequency: 400 Hz
- EIAST frequency: 10 Hz
- IP66 protection
- Smart dimensions: 34.5*13.5*5.8 mm without adaptable cable lengths (default: 1000mm *2)
- Applicable effort (adjustable)
- 0-5V analog output

TM-FAST-W range



In its **W** range, TM-FAST® offers a **wireless instrumented bolt** integrating the sensitive element (strain sensor) in the screw head and an **integrated measurement conditioner** (memory and measurement). Our latest prototype uses Peer-To-Peer communication via NFC (Near Field Communication).

The W version integrates an NFC chip on the head of the screw to recover the power supply of the reader during a reading. An application developed for this purpose can read the digital value transmitted by the conditioner and converts it into Load.

Peer-to-Peer communication & data transfer
Pairing quicker than Bluetooth technology
No power supply requirement from the bolt





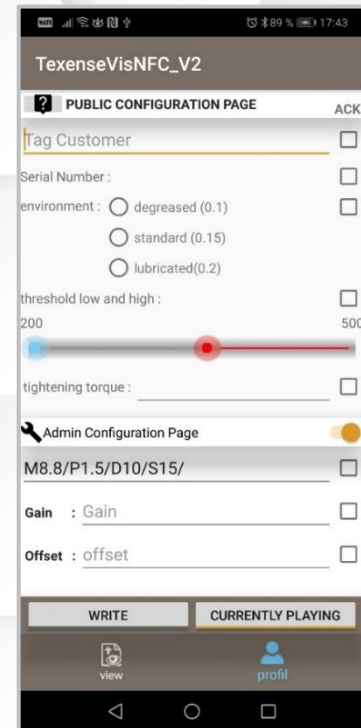
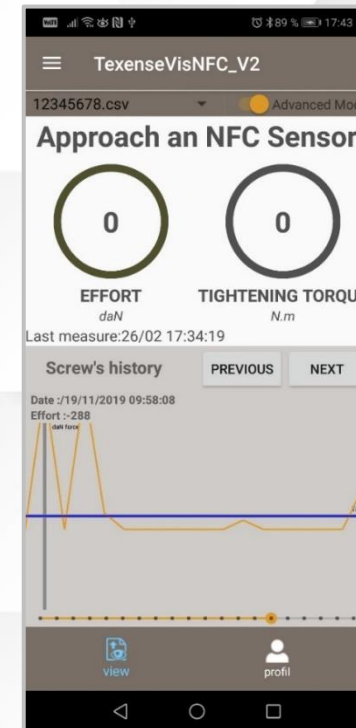

Dedicated smartphone application

- Monitoring, measurement data & user inputs
- Load and tightening torque
- Bolt ID
- Timestamp, historic data
- Assembly information
- CSV format file export



TM-FAST® range overview





Product name	Features	Description	Technical specs	Dimensional range M4 to M33 specifications	Strengths and weaknesses
 TM-FAST-TH-EM	Strain sensor Remote measurement conditioner	Wired version → no separation between conditioner and screw head	Strain sensors use the sensitivity of gauges to measure the intensity of tensile effects on the bolt. The gauge is fixed inside the screw head, with no degradation of the mechanical strength of the bolt. <ul style="list-style-type: none"> • 5% FS hysteresis error • Repeatability error 0.2% • FS Non-linearity error 0.5% FS • Temperature range -20/+100°C • IP66 protection • TH max cut-off frequency: 15 kHz • EI max cut-off frequency: 400 Hz • Smart dimensions: 34.5*13.5*5.8 mm without adaptable cable lengths (default: 1000mm *2) • Applicable effort (adjustable) • 0-5V analog output 	ALL	High speed but inconvenient in installation
 TM-FAST-TH-MC	Strain sensor Remote measurement conditioner Magnetic connector	Magnetic connector on the screw head → separation with conditioner		M9 to M33	High speed and convenient in installation but remote specific conditioner
 TM-FAST-TH-CO	Strain sensor Remote measurement conditioner	Binder connector between screw head and conditioner		M9 to M33	High speed and convenient in installation but remote specific conditioner
 TM-FAST-EI-MC	Strain sensor Integrated measurement conditioner Magnetic connector	Works with the TM-FAST-EIAST dongle → additional layer, allowing filtering and conversion of analog value into daN. This dongle offers a serial link via USB		M9 to M33	Convenient in installation and one remote conditioner for many sensors
 TM-FAST-W	Strain sensor Integrated measurement conditioner Wireless technology	Prototype with Peer-To-Peer communication via NFC Pairing quicker than Bluetooth technology No power supply requirement from the bolt		M9 to M33	One-shot wireless measurement

Based on more than 20 years of experience, TEXYS Group brings **innovation** one step forward with the TM-FAST® solution, from **initial fastening** to **preventive maintenance** through instrumented bolts for **connected assemblies**.

For that purpose, TEXYS has developed its own dedicated **software**, which reads & displays **live values for each instrumented bolt**.

This software is the cornerstone for the **monitoring of instrumented assemblies** and a **major asset for preventive maintenance**.

Key features:

-  **Live load & tightening** values to help maintenance operations
-  **Data history** to keep track of any potential variation
-  **Simple and intuitive** interface for all users

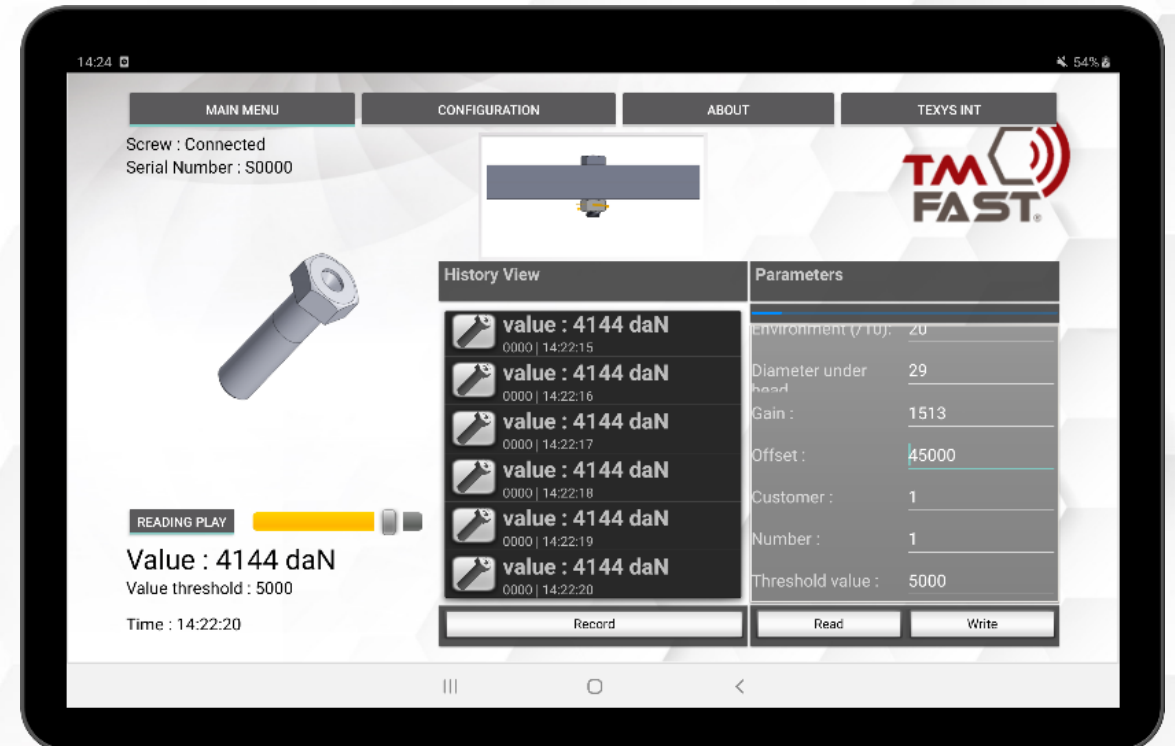

Application areas



Measuring systems are regularly **put to the test**, undergoing a variety of high stresses depending on the **environment**.

With the **TM-FAST®** instrumented screws, TEXYS Group offers an **adapted technological solution** for **all types of industries**, which can be adapted to a **multitude of applications** requiring monitoring of clamping loads, surveillance and preventive maintenance of infrastructures.



Aeronautics, Space & Defense



Transportation



Energy



Industry



SHM – Civil Engineering

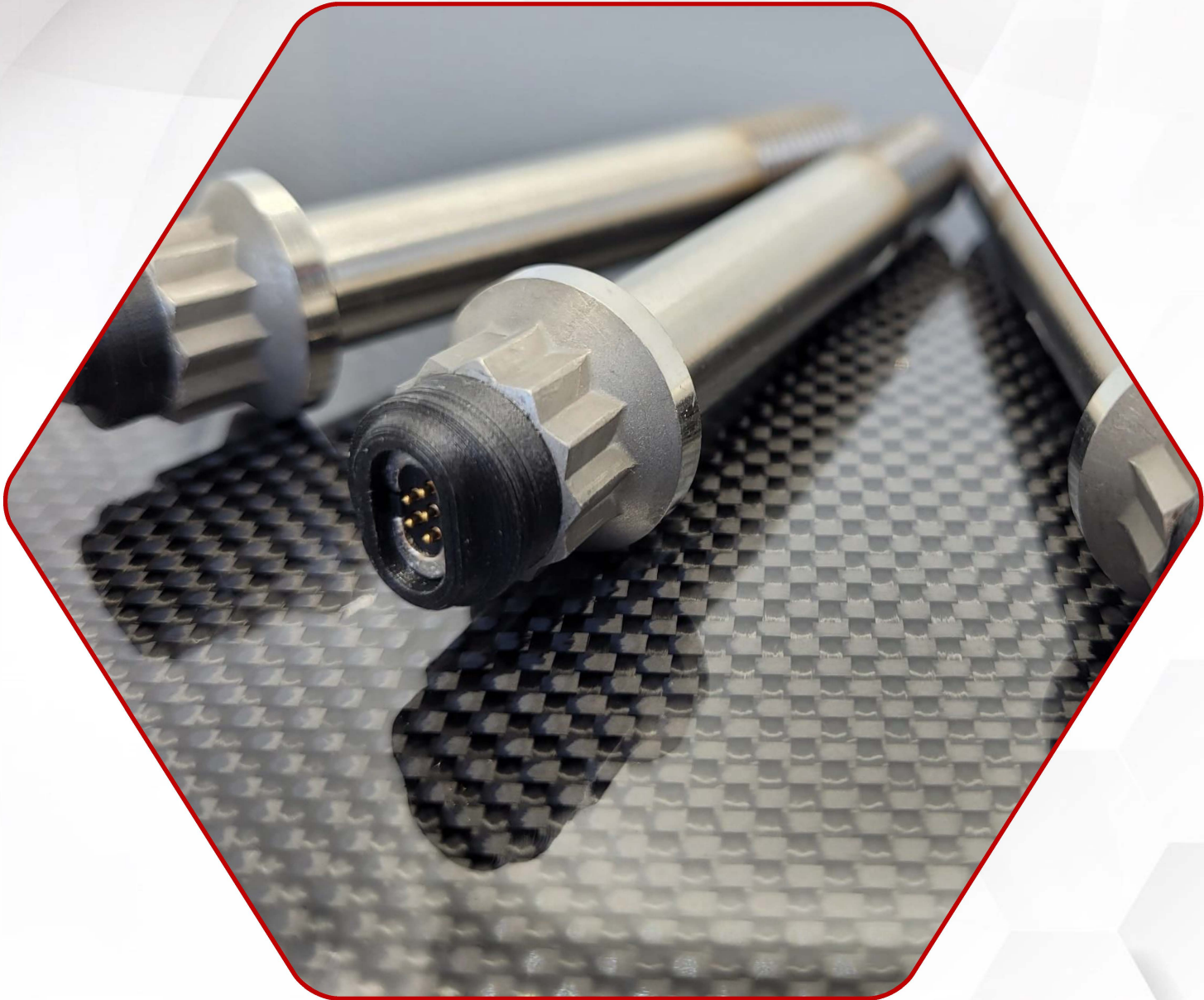

THANK YOU

Texys Group



a brand of
texys
GROUP

